

KML-631M_H

LOW-PROFILE MODULAR CRESCENT CUBER

Item # _____

Project: _____

Qty: _____

*AutoCad available on KCL

KML-631M_H

1/08

Item # 13192

CUBER DIMENSIONS

W x D x H

KML-631M_H
30 x 27^{3/8} x 26

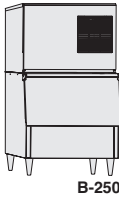

KML-631MAH



Air-Cooled
Shown on an optional
B-500

KML-631MWH

Water-Cooled

KML-631MRH

Remote Air-Cooled

- Up to 636 lbs. of ice production per 24 hours
- Durable stainless steel exterior
- Individual crescent cube
- Protected by *HoshiGuard* antimicrobial agent 
- CycleSaver® Design 
- EverCheck® alert system 
- Stainless steel evaporator
- Removable air filters (Air-cooled models only)
- R-404A Refrigerant
- Complies with California Energy Commission guidelines (CEC)

* The KML-631MRH is ENERGY STAR certified.

Warranty

Valid in United States, Canada, Puerto Rico, & U.S. Territories. Contact factory for warranty in other countries.

Three Year - Parts & Labor on entire machine.

Five Year - Parts & Labor on: Evaporator

Five Year - Parts on: Compressor, air-cooled condenser coil.



© HOSHIZAKI AMERICA, INC.

618 Hwy. 74 S., Peachtree City, GA 30269

TEL 1-800-438-6087

FAX 1-800-345-1325

www.hoshizaki.com



KML-63IM_H LOW-PROFILE MODULAR CRESCENT CUBER

DIMENSIONS
W x D x H
KML-63IM_H
30 x 27^{3/8} x 26

- Air-cooled
- Water-cooled
- Remote Air-cooled

AIR-COOLED

Water Temp° F.	50°	70°	90°
Air Temp° F.			
70°	575	553	515
80°	558	525	481
90°	553	501	459

WATER-COOLED

Water Temp° F.	50°	70°	90°
Air Temp° F.			
70°	632	631	593
80°	632	631	572
90°	631	630	579

REMOTE AIR-COOLED

Water Temp° F.	50°	70°	90°
Air Temp° F.			
70°	636	622	578
80°	626	604	545
90°	622	589	535

UTILITY CONSUMPTION

Model Number	Ice Production Per Cycle		KWH per 100 LBS. 90/70	Potable Water Gal. per 100 lbs.	Condenser Water Gal. per 100 lbs.
	Lbs.	Cubes			
KML-631MAH	9.0	480	6.2	26.0	N/A
KML-631MWH	9.7	480	4.4	24.8	119
KML-631MRH	9.4	480	5.3	24.0	N/A

SPECIFICATIONS

Model Number	Condenser	Amperage	Min. Circuit Ampacity	Shipping Weight
KML-631MAH	Air-Cooled	7.6	20 A	220 lbs.
KML-631MWH	Water-Cooled	6.8	20 A	220 lbs.
KML-631MRH	Remote Air-Cooled	7.8	20 A	220 lbs.

STORAGE BINS

Model Number	Application Capacity	ARI-Rated Capacity
B-250	250 lbs.	230 lbs.
B-500	500 lbs.	360 lbs.
B-700	700 lbs.	550 lbs.
B-800	800 lbs.	600 lbs.
B-900	900 lbs.	660 lbs.
B-1150	1150 lbs.	N/A
B-1300	1275 lbs.	N/A
B-1500	1500 lbs.	N/A
B-1650	1605 lbs.	N/A

ELECTRICAL & PLUMBING/KML-63IM_H

- 208-230/60/1 (3 wire with dedicated neutral for 115V)
- 20 Amp Max Fuse/HACR Breaker Size
- 1/2" OD copper or equivalent independent potable water supply
- 3/4" FPT independent drain connection



© HOSHIZAKI AMERICA, INC.

618 Hwy. 74 S., Peachtree City, GA 30269

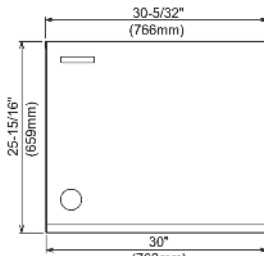

FRONT VIEW

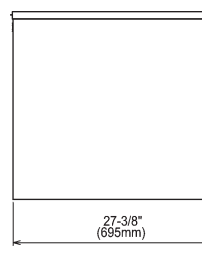

SIDE VIEW

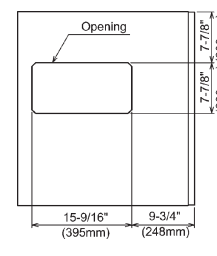

ICE DROP ZONE

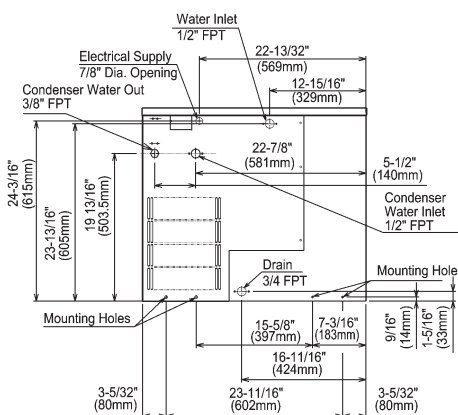

WATER-COOLED UNIT

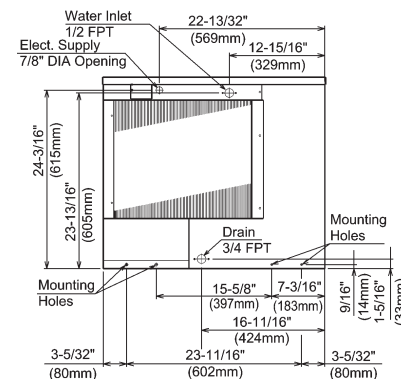

AIR-COOLED UNIT

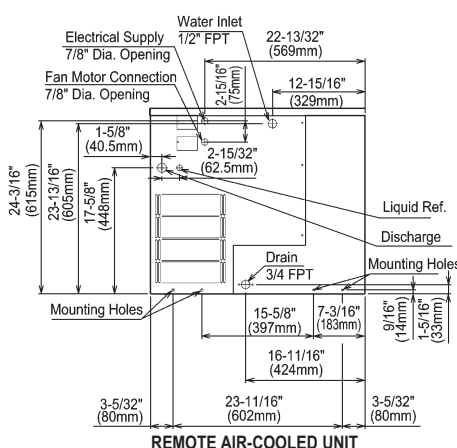

REMOTE AIR-COOLED UNIT

URC-9F Remote Condenser (Sold Separately)
For Use with KML-631MRH

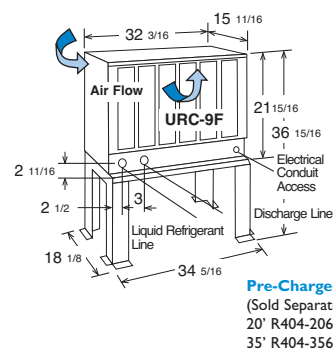

Pre-Charged Tubing Kits
(Sold Separately)
20' R404-2068-2
35' R404-3568-2

Voltage supply for the URC Remote Condenser is supplied from the Ice Maker. No additional circuit is required.

OPERATING LIMITS

- Ambient Temp Range 45 - 100°F
- Water Temp Range 45 - 90°F
- Water Pressure 10 - 113psig
- Voltage Range 187 - 253V

CONDENSING UNIT

- Voltage Range 104 - 127V
- Ambient Temp Range -22 - 122°F

SERVICE

- Panels easily removed and all components accessible for service.
- Removable/cleanable air filters (Air-cooled models only)

TEL 1-800-438-6087

FAX 1-800-345-1325

www.hoshizaki.com

Printed in U.S.A.

