

REFRIGERATOR MANUFACTURER
Turbo air
 more durable, efficient, beautiful

4184 E. Conant St.
 Long Beach, CA 90808
 Tel. 310-900-1000
 Fax. 310-900-1077
www.turboairinc.com

Project :	
Model # :	
Item # :	Qty :
Available W/H :	
Approval :	

Clup Top Beer Dispensers

*Underbar Equipment
 Super Deluxe Series*

**3 YEAR PARTS & LABOR
 WARRANTY**

Model : TCB-4SD/SB



TCB-4SD



TCB-4SB

- Does not include keg couplers

≡ FEATURES & BENEFITS ≡

- **Efficient refrigeration system**
 Turbo Air's refrigerators are designed with oversized and balanced R-134A (CFC Free) refrigeration systems. These include efficient evaporators and condensers for faster cooling and greater efficiency.
- **Forced air cooling system**
 Fast cooling and balanced temperature throughout the cabinet.
- **Stainless steel cabinet construction**
 Super Deluxe (SD) models boast a stainless steel exterior (except galvanized steel back and bottom). SB models are attractive wear-resistant black vinyl exterior. Heavy gauge stainless steel countertop and club top lids are perfect for sanitation and durability. Interior is stainless steel except galvanized steel top. Turbo Air Club Top model guarantees utmost in cleanliness and long product life. It also can add a touch of style to the most refined setting.
- **High-density polyurethane insulation**
 The entire cabinet structure is foamed-in-place using high density, CFC free polyurethane insulation.
- **3" diameter stainless steel insulated beer columns**
- **Club top (TCB) models provide easy access to the interior area**
 Club Top is a combined functional cabinet of direct draw cold beer dispenser and glass chiller. This convenient model provides easy access to interior storage area of the refrigerator for chilled beer glasses.
- **Easy to glide stainless steel club top lids**
- **Ergonomically designed doors**
 Customers' fatigue fades away with easy grip handles and doors that open effortlessly. These features along with self-closing doors make this the ultimate choice in customer convenience.
- **Side mount compressor unit**
 By positioning the compressor on the side of the unit, refrigerators can now be serviced without being moved. Our innovative, front breathing feature also allows this model to provide high efficiency in narrow spaces.
- **Refrigerator holds 33°F ~ 38°F for the best in beverage preservation**



Model	Swing Door	1/2 Barrels	HP	AMPS	Crated Weight (lbs.)	L x D* x H† (inches)
TCB-4SD	3	4	1/3	7.5	445	903/8 x 271/4 x 385/8
TCB-4SB	3	4	1/3	7.5	445	903/8 x 271/4 x 385/8

Clup Top Beer Dispenser

Underbar Equipment
Super Deluxe Series

Model : TCB-4SD/SB

ELECTRICAL DATA	
Voltage	115/60/1
Plug Type	Ⓜ NEMA 5-15P
Full Load Amperes	7.5
Compressor HP	1/3
Refrigerant	R-134A
Cord Length (ft.)	9
DIMENSIONAL DATA	
1/2 Barrels	4
Ext. Length Overall in.	90 ³ / ₈ (2296mm)
Ext. Depth Overall in.*	27 ¹ / ₄ (692mm)
Ext. Height Overall in.†	38 ⁵ / ₈ (980mm)
Net Weight lbs.	425
Gross Weight lbs.	445
# of Swing Door	3

Design and specifications subject to change without notice.
Actual shipping weight may differ due to extra packing materials for product protection.
* Depth does not include 2" for rear spacers.
† Height does not include 5" for caster height. Height does not include 15-1/8" for draft arm.

■ **WARRANTY : 3 Year Parts and Labor Warranty
Additional 2 Year Warranty on Compressor**

- Double faucet beer tower standard
- Door locks standard
- Self-contained system
- 4" swivel casters standard
- 2" casters available (optional)
- 6" adjustable legs available (optional)

PLAN VIEW

(unit : inch)

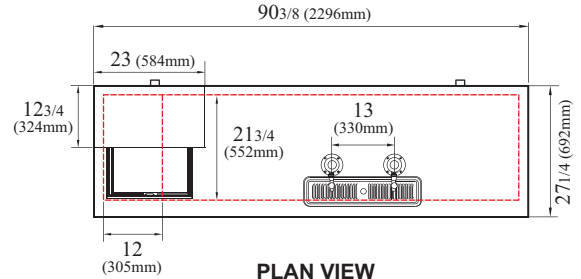

PLAN VIEW

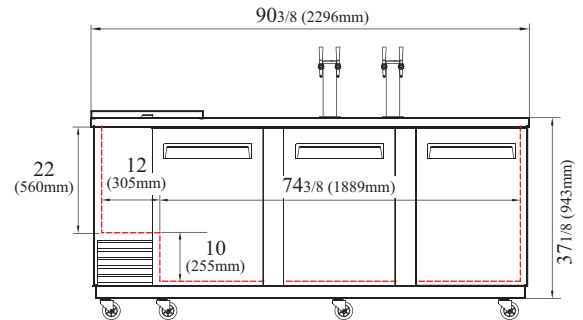

FRONT VIEW

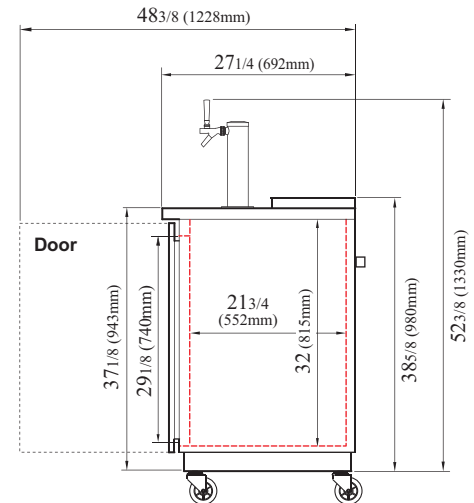

SIDE VIEW

Ver.201504



- Turbo Air : 800-627-0032
- GK : 800-500-3519
- Warranty : 800-381-7770
- AC : 888-900-1002

REFRIGERATOR MANUFACTURER
Turbo air

GERMAN KNIFE

RADIANCE

GREEN WORLD

AIR CONDITIONER MANUFACTURER
Turbo air