



TRUE FOOD SERVICE EQUIPMENT, INC.

2001 East Terra Lane • O'Fallon, Missouri 63366-4434 • (636)240-2400
 Fax (636)272-2408 • Toll Free (800)325-6152 • Intl Fax# (001)636-272-7546
 Parts Dept. (800)424-TRUE • Parts Dept. Fax# (636)272-9471 • www.truemfg.com

Project Name: _____

Location: _____

Item #: _____ Qty: _____

Model #: _____

A/A #

SIS #

Model:

TSSU-72-15M-B-HC

Food Prep Table:

Mega-Top Solid Door Sandwich/Salad Unit with Hydrocarbon Refrigerant



TSSU-72-15M-B-HC

- ▶ True's salad/sandwich units are designed with enduring quality that protects your long term investment.
- ▶ Factory engineered, self-contained, capillary tube system using environmentally friendly R290 hydrocarbon refrigerant that has zero (0) ozone depletion potential (ODP), & three (3) global warming potential (GWP).
- ▶ Patented forced-air design holds 33°F to 41°F (.5°C to 5°C) product temperature in food pans and cabinet interior.
- ▶ Complies with and listed under ANSI/ NSF-7.
- ▶ Exterior - stainless steel front, top and ends. Corrosion resistant GalFan coated steel back.
- ▶ Stainless steel, patented, foam insulated lid and hood keep pan temperatures colder, lock in freshness and minimize condensation. Removable for easy cleaning.
- ▶ Interior - attractive, NSF approved, clear coated aluminum liner. Stainless steel floor with coved corners.
- ▶ 8 7/8" (226 mm) deep, 1/2" (13 mm) thick, full length removable cutting board included. Sanitary, high density, NSF approved white polyethylene provides tough preparation surface.
- ▶ Heavy duty PVC coated wire shelves.
- ▶ Foamed-in-place using a high density, polyurethane insulation that has zero ozone depletion potential (ODP) and zero global warming potential (GWP).

ROUGH-IN DATA

Specifications subject to change without notice. Chart dimensions rounded up to the nearest 1/8" (millimeters rounded up to next whole number).

Model	Doors	Shelves	Pans (top)	Cabinet Dimensions (inches) (mm)			HP	Voltage	Amps	NEMA Config.	Cord Length (total ft.) (total m)	Crated Weight (lbs.) (kg)
				W	D†	H*						
TSSU-72-15M-B-HC	3	6	15	72 3/8 1839	34 1/8 867	40 3/8 1026	1/2 N/A	115/60/1	7.2 N/A	5-15P	7 2.13	445 202

† Depth does not include 1" (26 mm) for rear bumpers.

* Height does not include 6 1/4" (159 mm) for castors or 6" (153 mm) for optional legs.



APPROVALS:

AVAILABLE AT:

Model:
TSSU-72-15M-B-HC

Food Prep Table:
*Mega-Top Solid Door Sandwich/Salad Unit with
Hydrocarbon Refrigerant*



STANDARD FEATURES

DESIGN

- True's commitment to using the highest quality materials and oversized refrigeration systems provides the user with colder product temperatures, lower utility costs, exceptional food safety and the best value in today's food service marketplace.

REFRIGERATION SYSTEM

- Factory engineered, self-contained, capillary tube system using environmentally friendly R290 hydrocarbon refrigerant that has zero (0) ozone depletion potential (ODP), & three (3) global warming potential (GWP).
- Energy efficient, factory balanced refrigeration system with guided airflow to provide uniform temperature in food pans and cabinet interior.
- Patented forced-air design holds 33°F to 41°F (.5°C to 5°C) product temperature in food pans and cabinet interior. Complies with and listed under ANSI/NSF-7.
- Sealed, self-lubricating evaporator fan motor and larger fan blades give True sandwich/salad units a more efficient, low velocity, high volume airflow design.
- Condensing unit access in back of cabinet, slides out for easy maintenance.

CABINET CONSTRUCTION

- Exterior - stainless steel front, top and ends. Corrosion resistant GalFan coated steel back.
- Interior - attractive, NSF approved, clear coated aluminum liner. Stainless steel floor with coved corners.
- Insulation - entire cabinet structure and solid doors are foamed-in-place using a high density, polyurethane insulation that has zero ozone depletion potential (ODP) and zero global warming potential (GWP).

- 5" (127 mm) diameter stem castors - locks provided on front set. 36" (915 mm) work surface height.

DOORS

- Stainless steel exterior with clear aluminum liner to match cabinet interior.
- Each door fitted with 12" (305 mm) long recessed handle that is foamed-in-place with a sheet metal interlock to ensure permanent attachment.
- Positive seal self-closing doors with 90° stay open feature. Doors swing within cabinet dimensions.
- Magnetic door gaskets of one piece construction, removable without tools for ease of cleaning.

SHELVING

- Six (6) adjustable, heavy duty PVC coated wire shelves. Two (2) right and two (2) left door shelf dimensions are 21 5/16" L x 16" D (548 mm x 407 mm). Two (2) center door shelf dimensions are 23 1/2" L x 16" D (597 mm x 407 mm). Four (4) chrome plated shelf clips included per shelf.
- Shelf support pilasters made of same material as cabinet interior; shelves are adjustable on 1/2" (13 mm) increments.

MODEL FEATURES

- Evaporator is epoxy coated to eliminate the potential of corrosion.
- 8 7/8" (226 mm) deep, 1/2" (13 mm) thick, full length removable cutting board. Sanitary, high-density, NSF approved white polyethylene provides tough preparation surface.
- Stainless steel, patented, foam insulated lid and hood keep pan temperatures colder, lock in freshness and minimize condensation. Removable for easy cleaning.

- Comes standard with 15 (1/2 size) 6 7/8" L x 6 1/4" W x 4" D (175 mm x 159 mm x 102 mm) clear polycarbonate, NSF approved, food pans in countertop prep area. Also accommodates 6" (153 mm) deep food pans (supplied by others).
- Countertop pan opening designed to fit varying size pan configurations with available pan divider bars. Varying size pans supplied by others.
- NSF/ANSI Standard 7 compliant for open food product.

ELECTRICAL

- Unit completely pre-wired at factory and ready for final connection to a 115/60/1 phase, 15 amp dedicated outlet. Cord and plug set included.



115/60/1
NEMA-5-15R

OPTIONAL FEATURES/ACCESSORIES

Upcharge and lead times may apply.

- 6" (153 mm) standard legs.
- 6" (153 mm) seismic/flanged legs.
- 2 1/2" (64 mm) diameter castors.
- Barrel locks (factory installed). Requires one per door.
- Additional shelves.
- Single overshelf.
- Double overshelf.
- Flat lid.
- Sneezeguard.
- 8 7/8" (226 mm) deep, 1/2" (13 mm) thick, composite cutting board.
- Crumb catcher. Requires crumb catcher cutting board for proper installation.
- Pan dividers.
- Exterior rectangular digital temperature display (factory installed).
- ADA compliant model with 34" (864 mm) work surface height.

PLAN VIEW

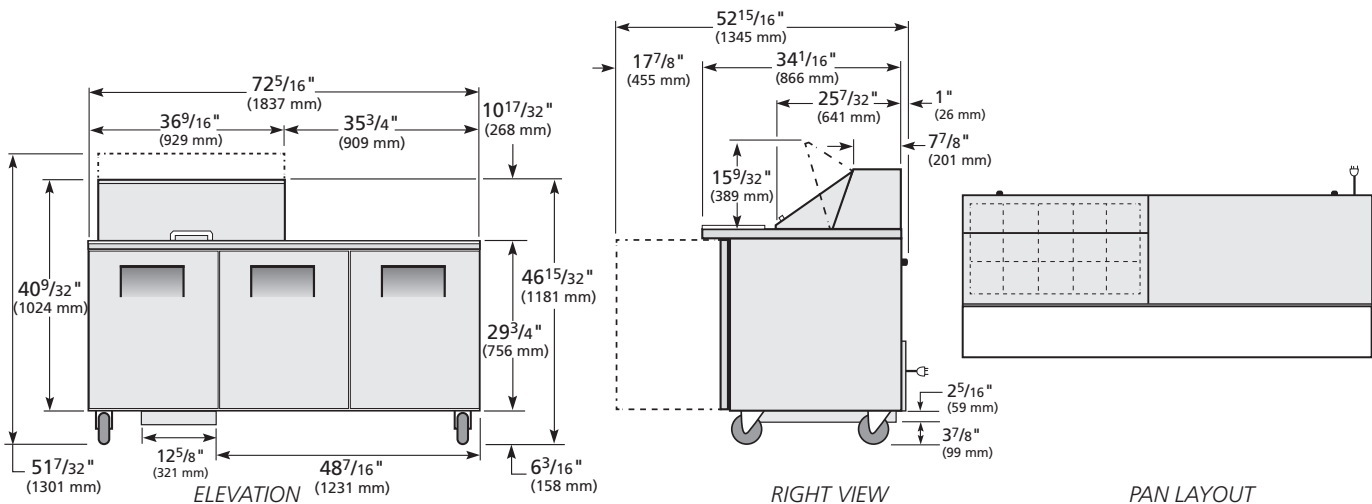

WARRANTY*
 Three year warranty on all parts and labor and an additional 2 year warranty on compressor.
 (U.S.A. only)

METRIC DIMENSIONS ROUNDED UP TO THE NEAREST WHOLE MILLIMETER

SPECIFICATIONS SUBJECT TO CHANGE WITHOUT NOTICE



Model	Elevation	Right	Plan	3D	Back
TSSU-72-15M-B-HC	TFN049E	TFN048S	TFN049P	TFN0493	

*RESIDENTIAL APPLICATIONS: True assumes no liability for parts or labor coverage for component failure, factory defect or any other damages for units installed in non-commercial foodservice or residential applications.

TRUE FOOD SERVICE EQUIPMENT